

SERPENTINE SNEEZE GUARD

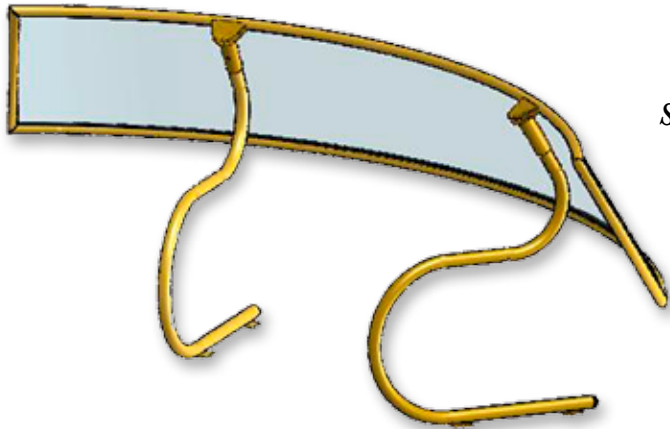

*Large Radius
Serpentine shown*

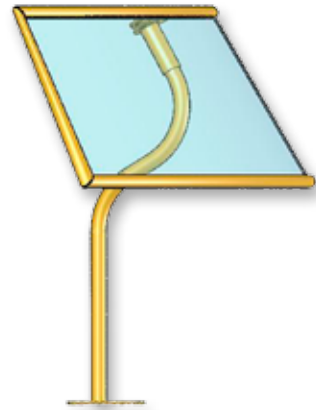

*Small Radius
Serpentine shown*

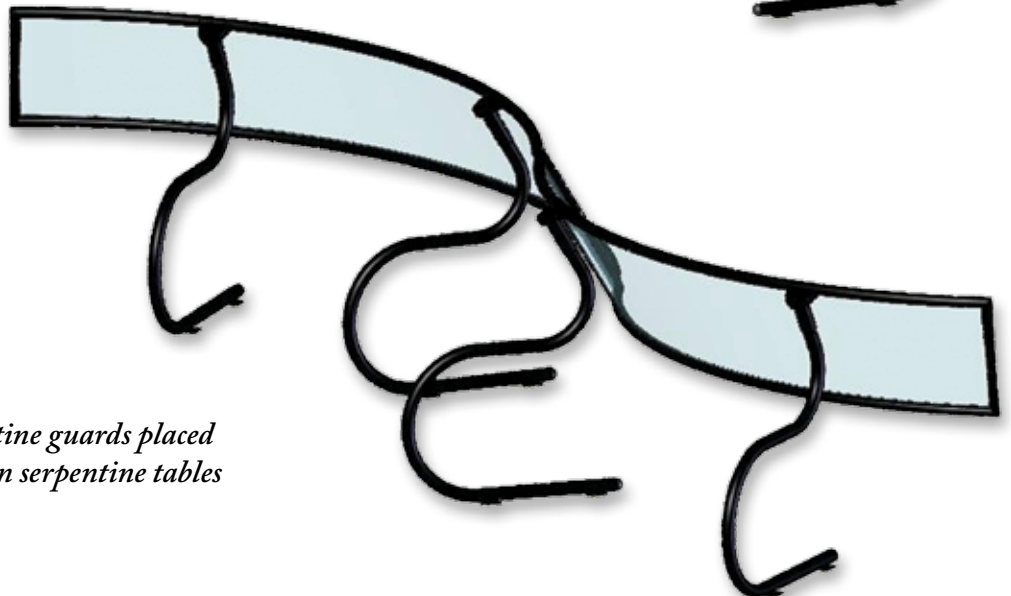
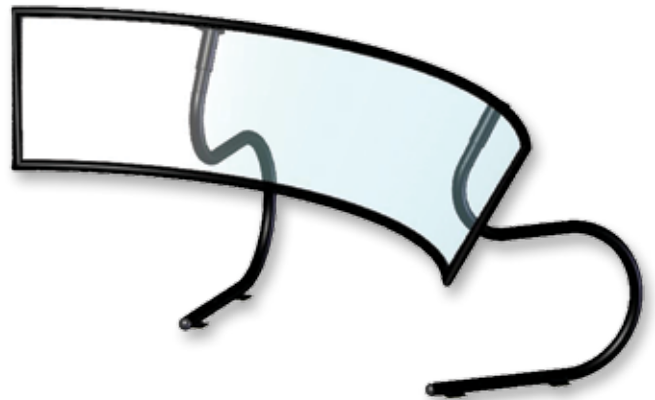

*Large and Small Radius Serpentine guards placed
together to protect food offerings on serpentine tables*



ANSI/NSF 2

* Images are computer renderings, not actual photos, some color variance may occur from what is rendered to the actual powder coat finish.

Phone: 800-569-2056

Fax: 573-449-7126

www.sneezeguardsolutions.com

SERPENTINE GUARD

SPECIFICATIONS

Serpentine table top view

large radius side

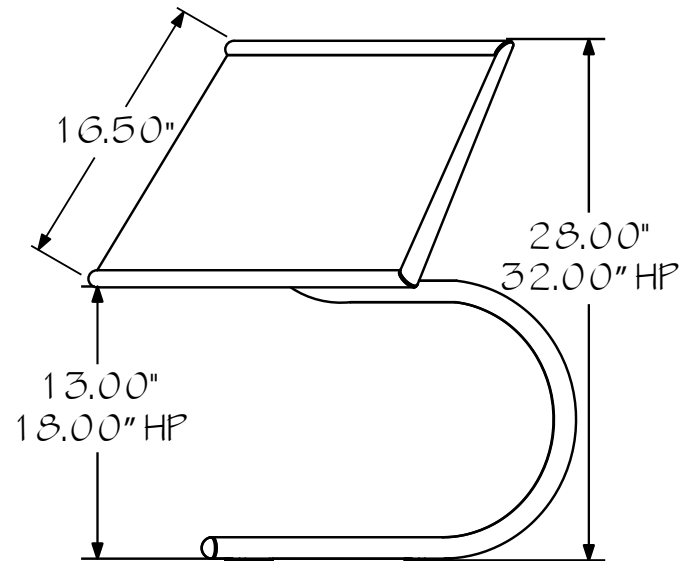
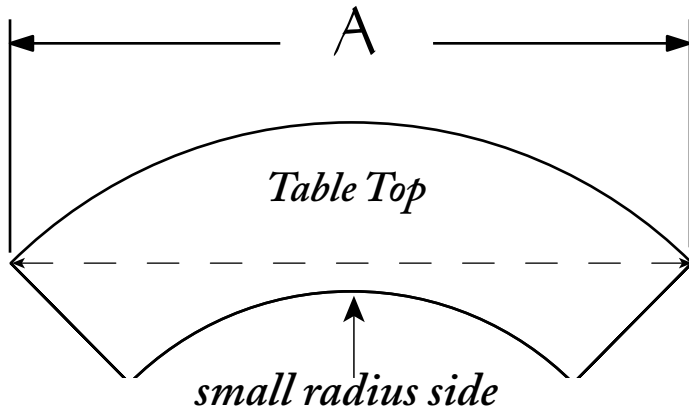

SERPENTINE GUARD

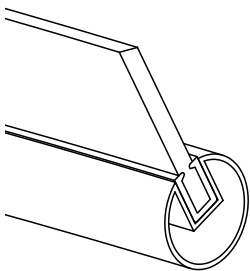

- Exclusive extruded 1" Groove Tube
- Mounted in rubber gasket
- 1.25" aluminum stands
- Scratch resistant acrylic food shield
- Powder coated finish

<i>Black</i>	<i>Gold</i>	<i>Description</i>	<i>Table measurment Distance "A"</i>	<i>Weight</i>
7501	7502	5' Small Radius	84"	14 lbs
7601	7602	5' Large Radius	84"	15 lbs
7701	7702	6' Small Radius	102"	15 lbs
7801	7802	6' Large Radius	102"	17 lbs

Add HP after model number to indicate that Hi-profile stands are desired for 18" wrist clearance.